

MT3A

Test Applications • Voltage Divider

Compact String Pot • Flight/Crash Test Applications

Dual Axis 360° Mounting Bracket

3, 9, 15 and 30-inch Stroke Range Options

Wet Environments • Aluminum Enclosure

GENERAL

Full Stroke Range Options	0-3, 0-9, 0-15, 0-30 inches, min.
Output Signal	voltage divider (potentiometer)
Accuracy	± 1.1% to 0.15% full stroke (see ordering information)
Repeatability	± 0.02% full stroke
Resolution	essentially infinite
Measuring Cable	Ø.019-in. nylon-coated stainless steel
Enclosure Material	anodized aluminum
Sensor Cover Options	aluminum or polycarbonate
Sensor	conductive plastic-hybrid potentiometer
Weight	0.5 lb. max.

ELECTRICAL

Input Resistance	10K ohms (± 10%)
Power Rating, Watts	2.0 at 158°F (70° C), derated to 0 @ 255°F (125°C)
Recommended Maximum Input Voltage	30V (AC or DC)
Electrical Stroke	94% ±4% of input voltage
Mating Plug	LEMO FGG.OB.304.CLAD52

MECHANICAL

Measuring Cable Tension Options	9, 14 and 33 oz.
Maximum Measuring Cable Acceleration	90 g

ENVIRONMENTAL

Enclosure	NEMA 4 / IP67
Operating Temperature	-40° to 250° F (-40° to 120°C)

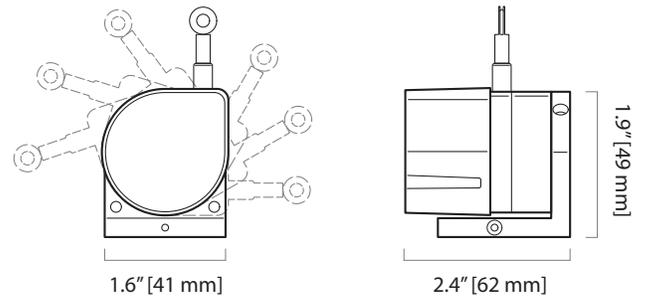

The MT3A is the solution for high-acceleration test applications in potentially wet environments. Just like the MT2A, the MT3A comes in 4 different full-stroke ranges, has a high-tension heavy-duty measuring cable designed for the demands of flight and automotive crash tests and comes with an easy to use 2-axis 360° rotation mounting bracket for installation in hard to fit areas.

For extreme high impact applications, the MT3A is now available with a rugged all aluminum sensor cover!

Output Signal

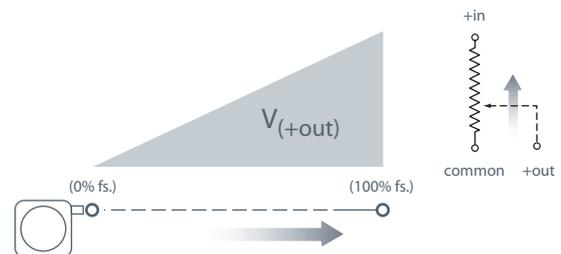

Outline Drawing:

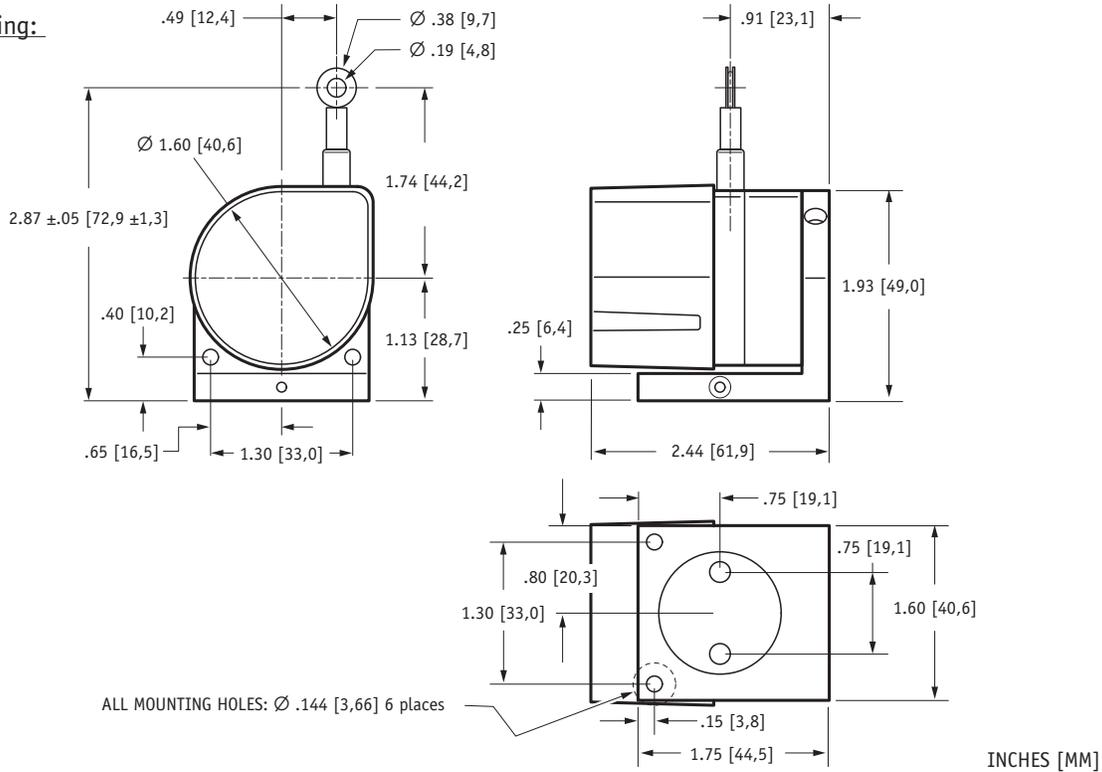

Ordering Information:

Model Number:

MT3A - **R** **A** **B** **- 10K -** **C**

order code: R A B C

Sample Model Number:

MT3A - 9E - 33 - 10K - C1A

- R** range: 9 inches
- A** measuring cable termination: eyelet
- B** measuring cable tension: 33 oz. (± 6 oz.)
- C** electrical connection: 15-ft cable w/end-mounted strain relief/aluminum cover

Full Stroke Range:

R order code:	3	9	15	30
full stroke range, min:	3 inches	9 inches	15 inches	30 inches
potentiometer cycle-life:	2.5×10^6	8.3×10^5	5.0×10^5	2.5×10^5
accuracy (% of full stroke):	1.1 %	.25%	.20%	.15%

Measuring Cable Termination:

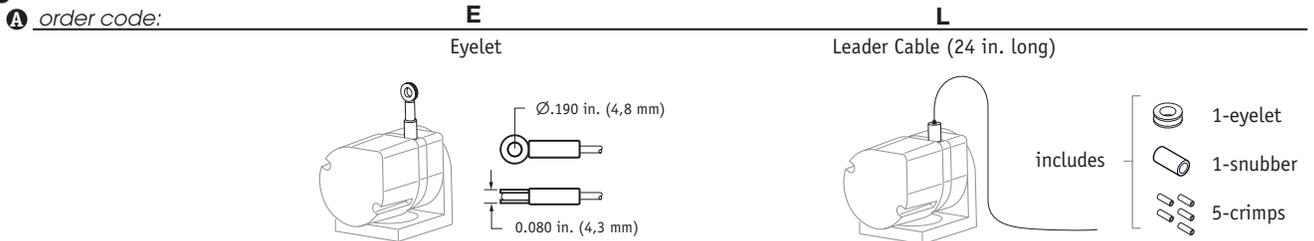

Measuring Cable Tension:

B order code:	9	14	33
tension:	9 (± 2) oz.	14 (± 4) oz.	33 (± 6) oz.
max. cable acceleration:	17 g	50 g	90 g

Ordering Information (cont.):

Electrical Connection/Sensor Cover:

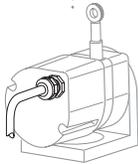
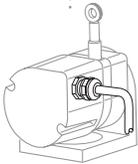
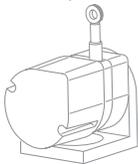
order code:	C1	C1A	C4	C4A	C2	C2A	C5	C5A							
sensor cover:	polycarbonate	aluminum	polycarbonate	aluminum	polycarbonate	aluminum	polycarbonate	aluminum							
electrical cable length:	15 ft (4.5 m)		30 ft (9 m)		15 ft (4.5 m)		30 ft (9 m)								
	 <p>end-mount strain relief</p>				 <p>side-mount strain relief</p>										
order code:	C3	C3A	C6	C6A	BC	BCA									
sensor cover:	polycarbonate	aluminum	polycarbonate	aluminum	polycarbonate	aluminum									
electrical cable length:	15 ft (4.5 m)		30 ft (9 m)		n/a		n/a								
	 <p>top-mount strain relief</p>				 <p>blank cover*</p>										
<p>Signal Connection Color Code</p>  <p>24 gauge, shielded</p>			<table border="1"> <thead> <tr> <th>color</th> <th>signal</th> </tr> </thead> <tbody> <tr> <td>Red</td> <td>+in</td> </tr> <tr> <td>Black</td> <td>common</td> </tr> <tr> <td>Green</td> <td>+out</td> </tr> </tbody> </table>	color	signal	Red	+in	Black	common	Green	+out	<p>* blank cover option is for customers who want to provide their own connector or strain relief. This cover comes without electrical wiring access holes so customer can drill to their requirements.</p>			
color	signal														
Red	+in														
Black	common														
Green	+out														

北京赛斯维测控技术有限公司
 北京市朝阳区望京西路48号
 金隅国际C座1002
 电话：+ 86 010 8477 5646
 传真：+ 86 010 5894 9029
 邮箱：sales@sensorway.cn
<http://www.sensorway.cn>

version: 9.0 last updated: November 15, 2012